

Dry Hydro Jet Massage Bed

AQUATIZER QZ-240

Specifications

Model number	Aquatizer QZ-240SG
Classification of protection against electric shock	Class I Type B
Mains supply	Single-phase 230 Vac, 50/60 Hz
Power input	4500 VA
Massage intensity	6 levels
Treatment timer	1 to 99 minutes
Preheating temperature setting	25 to 40°C
Other functions	Nozzle switching, automatic height detection, feet hold, preheating weekly timer, treatment melody setting, automatic air bleeding, high-temperature operation, and air cooling function.

Installation Conditions

Power supply facility	Installation of dedicated electrical leakage breaker is required on the facility side.
Floor load	Not less than 3.5 kPa (350 kgf/m ²)

External Appearance

Dimensions	2,290 (L) x 820 (W) x 1,075 (H) mm Bed height: 500 mm
Weight	Approx. 230 kg (approx. 450 kg when filled with water)
Water tank capacity	Approx. 220 L

Outline Dimensions

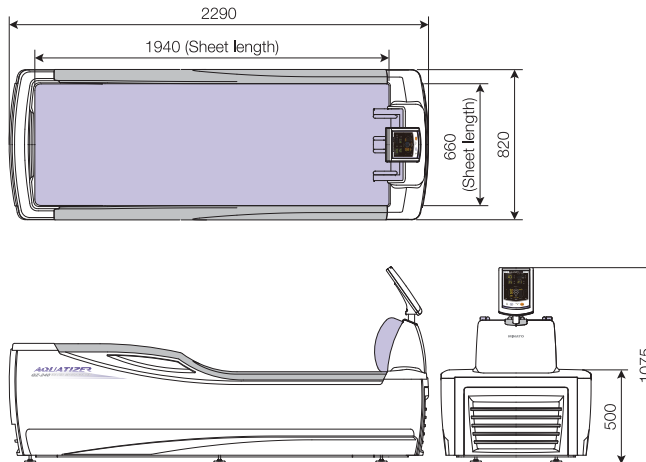

Hood-integrated model for further enhanced relaxation (Option)

A hood-integrated model is also optionally available in our lineup. By limiting the user's view of the surrounding, this model creates a treatment environment with higher levels of relaxation and comfort.

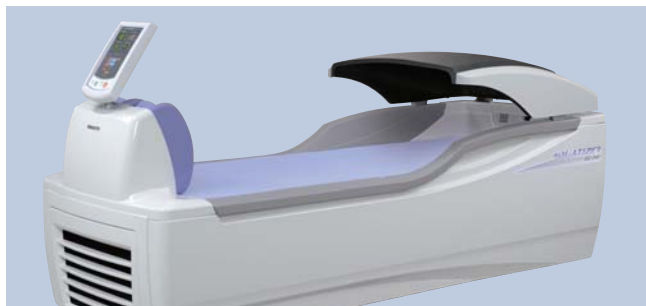

Safety Precautions

- Read the instruction manual carefully and use the equipment correctly before use.
- Perform regular inspections of the equipment.
- This equipment may require electrical work. Please contact the dealer where it is purchased. Deficiencies in the installation work may cause electric shock or fires.

- The product specification is subject to change without notice.
- The color of the actual product may differ from the color printed in the catalog.

•The available options, etc., are subject to change without notice.

MANUFACTURED BY:

MINATO

MINATO MEDICAL SCIENCE CO., LTD.

Overseas Division

13-11, Shinkitano 3-chome, Yodogawa-ku, Osaka 532-0025, Japan

E-mail: global@minato-med.co.jp

Tel: +81-6-6303-9759 / Fax: +81-6-6303-9761

<http://www.minato-med.co.jp/en/>



Nishiki Kobe Shizuoka
Facilities

DISTRIBUTED BY:



ZKN6377 ©27.09.10.000

Rehabilitation & Wellness
MINATO

Japan
Good Design
Award



Dry Hydro Jet Massage Bed

AQUATIZER QZ-240

MINATO MEDICAL SCIENCE CO., LTD.

Futuristic Comfort

A new line of Dry hydro jet massage beds pioneered by an innovative design concept.

Minato Medical Science's "Aquatizer QZ" series has constantly provided state-of-the-art instruments through unique design concepts in the area of dry hydro jet massage beds. These achievements and technologies have now been leveraged to generate a brand new dry hydro jet massage bed.

The "QZ-240" is designed with futuristic style and equipped with cutting-edge features such as 4 nozzles, foot airbags, and an automatic height setting function. The new model offers the most advanced treatment, comfort, and operability of the dry hydro jet massage bed.

The use of four selectable nozzles expands treatment options

A combination of these nozzles significantly increases treatment options, such as options for "wide areas" and "focusing on specific sites."

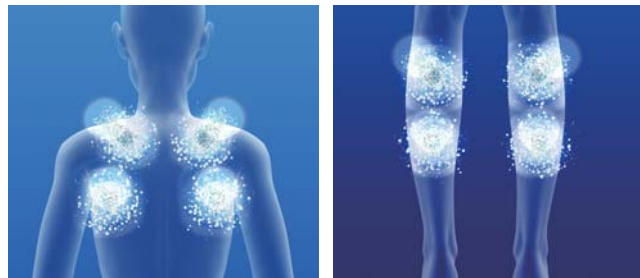

A wide variety of massage modes satisfy diverse user preferences

In addition to 7 basic massage patterns, the machine provides a favorite massage mode by enabling the patient to select either a "normal mode" or a "slow mode". The massage intensity can be selected from one of 6 levels.

Nozzle movement patterns

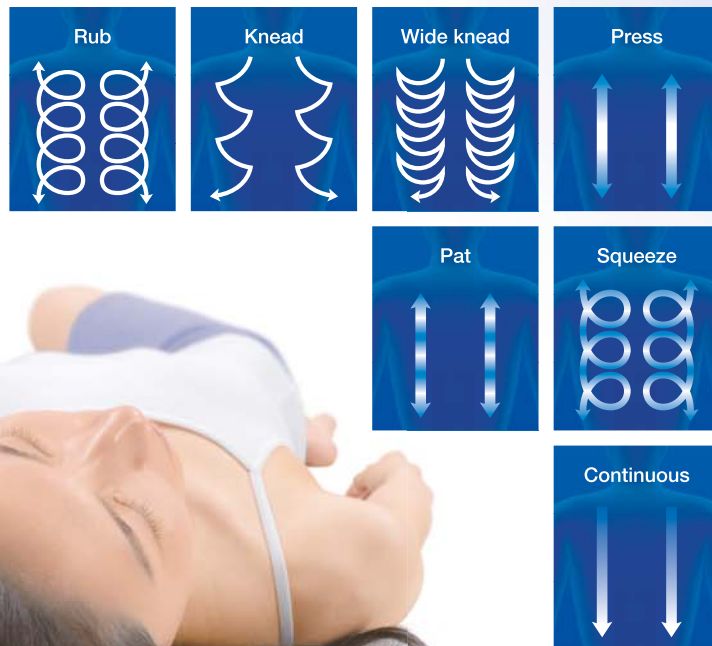

Compact and Futuristic Design, Providing Ease in Getting On and Off

Despite its compact size, 229 x 82 cm, the body has a wide seating area. A low bed height of 50 cm enables patients to easily get on and off the bed.



Foot Airbags, gently holding the legs

Maintaining a suitable leg position, while preventing them from spreading apart effectively enhances stimulation to the lower body. In addition, gently holding the feet helps to stabilize the body position and reduce head movement. The foot airbags also facilitate improved body posture when the patient lies on the bed.



Newly Mounted Sensor for Automatic Head Position Detection

When the patient lies on the bed, the sensor detects the position of the head, and the machine then automatically measures the height and identifies the desired areas to be massaged. Unlike conventional models, there is no need for the attendant to measure the height of each patient.

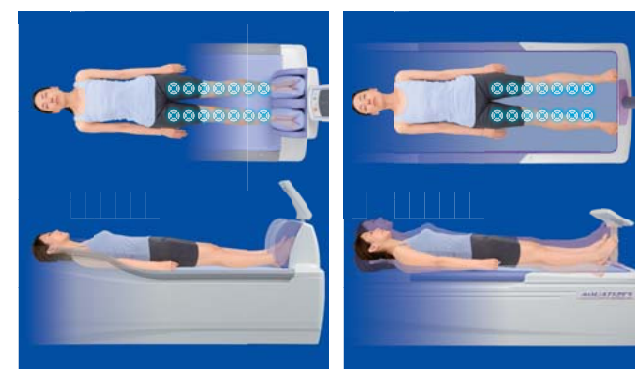
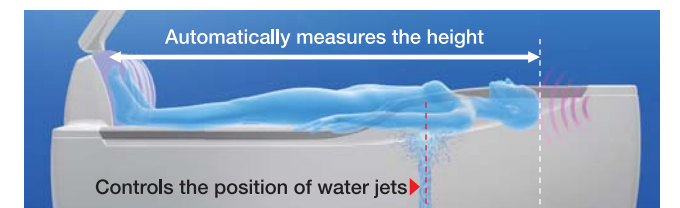
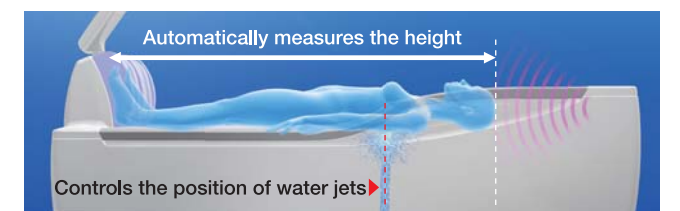

Aquatizer QZ-240SG

With the legs held steady, the water jets can precisely target the calves and thighs. The airbags also keep the body position stable, reducing head movement.

Previous Models of the Aquatizer

Legs are spread apart and moved outside the center zone of the water jets. The unstable body position also causes more head movement.